

Instruction Manual

Model 40-9.4EX
Explosion Proof Freezer

Installation and User's Instructions

For satisfactory and safe operation, you must thoroughly understand the operation of this cabinet and conditions that could be dangerous if instructions are not followed.

As the user of this cabinet, you are responsible to understand how it must be installed for proper function and operation. Any operator of the cabinet must be given adequate training before placing the cabinet in operation. You must be aware of warnings called out in the manual. You must follow all codes during installation and operation.

This freezer is for use in Class 1, Division 1, groups C and D Hazardous locations/

These instructions contain detailed information covering:

1. Uncrating, moving and locating the cabinet.
2. Electrical supply requirements
3. Operations and functions of controls.
4. Factory service assistance.
5. Wiring Diagram.

For your own benefit, take time to read this material and retain it for future reference. Record the cabinet model and serial number in the space provided. This will save a great deal of time should warranty information and service be required.

Cabinet Model Number: _____

Cabinet Serial Number: _____

Ship Date: _____

Uncrating Instructions

Instruct your drayman not to accept these goods from Transportation Company unless they are in perfect condition. If he discovers any damage the Carrier's Agent will make the proper notation on the receipt.

Unpacking instructions are located on the outside of the box. After uncrating cabinet, examine it thoroughly for freight damage. Should there be damage, file a claim and request immediate inspection. Retain all packaging until freight carriers claim agent has completed his investigation.

Should damage to your freezer not be discovered until after the goods are unpacked it should be reported at once to the Agent who will make an inspection and grant a concealed damage notation. This report must be made to the Agent of delivering carrier immediately. Unless this is done, all goods replaced on account of damage will be at your expense.

Locating the Cabinet

Select a location most convenient for usage, preferably a clean, dry area, away from sources of heat such as overhead blowers, radiators, ovens or direct sunlight. Location must also provide enough room to open lid at least 75°.

For Satisfactory Operation

The cabinet should be free standing with a minimum of three (3) inches between the cabinet rear / sides and the wall to allow air flow over the compressor and machinery compartment. This unit is not intended for built in operation.

Electrical Supply Requirements

The electrical power supply must be installed according to the latest edition of the National Electrical Code—specifically Article 510 – Hazardous (Classified) Locations – Specific. Appropriate materials and wiring methods must be used in order to comply with the current National Electric Code for Class 1, Group C and D area installation. All local and other appropriate codes must be followed.

The installation must be made by a licensed professional electrician and contractor.

Power Specification: 115 Volt, 60 Cycle, 1 Phase.

Minimum Wire Size: 14 AWG

Running AMP: 8

Grounding

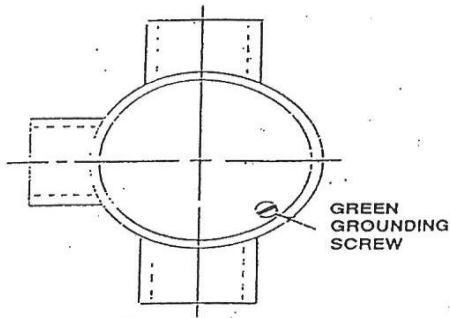

WARNING! For personal safety, this cabinet must be properly **grounded**. The ground wire to the cabinet must be installed on the green screw located in the conduit outlet box.

The conduit outlet box is where the incoming power wires are connected to the cabinet wires.

The incoming ground wire must be properly installed from the power supply. Consult a licensed electrician if you have any doubt about this wire being properly installed.

WARNING! Be absolutely sure that the surrounding location has been checked for

the absence of explosive concentrations before any electrical work is started.

Overcurrent Protection: 20 amps. (If fuses are used, use time delay type)

Operation & Functions of Controls

CAUTION: To prevent ignition of hazardous atmospheres, disconnect the product from the supply circuit before opening electrical boxes. Keep assembly tightly closed when in operation.

The rear side panel is removable to allow access to compressor and electrical components. The thermostat is located on the front left side of freezer when facing the cabinet. To adjust the thermostat, turn the black knob until the red indicating pointer lines up with the desired set point. The indicating pointer may be adjusted to read in degrees “C” or degrees “F”.

The refrigeration system is hermetically sealed type consists of compressor designed for hazardous locations, shell condenser and cold wall evaporator. Refrigerant charge is 8.75 ounces of R-404A. Thermostat is United Electric Type UE820E.

Lid Seal

The flexible lid construction permits lid conformity to the cabinet that is not perfectly level. If the lid raises or appears warped on one corner, raise the lid open and close it sharply. The lid will flex, forming a gasket seal.

Lid Adjustment

To align the front of the lid with the front of the cabinet, shims may be added or removed between the top part of the hinge and the lid.

To align the side of the lid with the side of the cabinet, loosen the four screws that fasten the top of the hinge to the lid. The top part of the hinge and the lid.

To align the side of the lid with the side of the cabinet, loosen the four screws that fasten the top of the hinge to the lid. The top of the hinge has elongated holes which will permit the lid to be moved from side to side. After alignment, tighten the mounting screws.

To adjust the distance between the cabinet and the lid at the hinge side, loosen the screws in the lower part of the hinge. The lower part of the hinge has elongated holes that will permit the up and down adjustment. Tighten the mounting screws after proper adjustment has been obtained.

Lid Removal

When removing the lid, remember the hinges are under spring tension, therefore, caution must be used.

Remove the top two screws that mount the lower part of the hinge to the cabinet. Push firmly against the hinge while removing the remaining two screws and allow the hinge to swing up slowly.

To install the lid, reverse the order of removal.

Sub-Lids

These lids are for the protection of your materials and should be used in place.

Defrosting and Cleaning

While scraping frost off interior surfaces with a plastic scraper will delay the need, a complete defrost will be periodically required. To defrost:

1. Unload cabinet of product.
2. Disconnect or turn off power supply
3. Open freezer lid and remove any shelving and or baskets.
4. Wipe all wall surfaces clean and dry.

5. Return all components, turn on power supply.
6. Once cabinet has attained desired temperature, reload cabinet with product.

CAUTION

Any temperature below 0 deg Centigrade or 32 deg Fahrenheit provides a potential condition to cause freezing of water or material contain water. Material containing water solutions of sodium (salt) or sugar will freeze at slightly lower temperature, depending on the content of the solution. Because all warm blooded creatures are composed of a great percent of water with salinity, they are subject to freezing whenever the body cells, parts or extremities reach temperatures below freezing. Therefore, it behooves the use of caution whenever you use a freezer or handle a frozen product that is at temperature below 0 deg Centigrade or 32 deg Fahrenheit.

Use protective clothing when contacting the inside of a freezer or products stored in a freezer. Hands should be dry and protected with Cryo-Gloves. Arms should be protected by sleeves or arm insulated Cryo-Gloves.

Other parts of the body that may be exposed to the cold should be protected by coats, insulated aprons etc. Frozen items / packages are hard and often slippery, therefore foot protection should be considered such as hard-toed shoes or foot guards in the event that they be dropped.

Factory Service Assistance

A customer telephone service is available to provide information and answer questions regarding warranty, care, use, maintaining and service of your cabinet and accessories.

To facilitate handling your request, please provide the following information when you call:

1. Complete cabinet model number and its serial number. This can usually be found on the back upper left hand corner of the unit.
2. Invoice Number if available and name of company who supplied and installed the cabinet.
5. Difficult compressor starting are indications of electrical supply problems.
6. Excessive frost buildup on cabinet walls or cooling coils reduces efficiency of refrigeration system.
7. Should you believe cabinet runs too much, check time compressor is on and how long it is off, plus the temperature of room near the compressor compartment.

Should your call regard a performance problem, the following information is very important:

1. When did the performance problem develop?
2. Describe exactly what the cabinet does or does not do that caused your dissatisfaction.
3. If cabinet was serviced, have your service bill available so you can describe any work done. Also furnish service companies telephone number. Often the factory can talk directly to the service person to help resolve problems.

If a problem developed after cabinet has been operating for a while, try to recall if there have been any changes in your establishment. This possibility could have affected the cabinet's performance. Some examples you may not have considered include:

1. Extra electrical equipment added and placed on same power circuit causing overloading.
2. Seasonal equipment such as air conditioning or heating may affect cabinet performance only certain times a year.
3. Heating and cooling equipment can affect cabinet performance by excess electrical load, or by discharging warm or cool air into cabinet storage or machinery compartment.
4. Rearrangement of equipment can change store air patterns and cabinet operation.