

# ScientTemp<sup>TM</sup>

3565 S. Adrian Hwy  
Adrian, MI 49221  
Ph: 517-263-6020  
[www.scientemp.com](http://www.scientemp.com)

## Operating and Installation for Moderate Cold Chest Freezers

**For Model's:** 34-05    34-07    34-09  
                  34-15    34-20    34-25

**Customer Service / Replacement Parts:**

Email: [tracy@scientemp.com](mailto:tracy@scientemp.com)  
Ph: 517-263-6020 Ext 102

**Technical Support:**

Email: [stuart@scientemp.com](mailto:stuart@scientemp.com)  
Ph: 517-263-6020 Ext 101

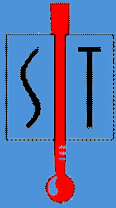

# TABLE OF CONTENTS

---

<b>CONTACTING THE FACTORY.....</b>	<b>1</b>
<b>IMPORTANT BEFORE YOU START.....</b>	<b>1</b>
<b>PRECAUTIONS AND SAFETY.....</b>	<b>2</b>
<b>CHOOSING THE BEST LOCATION.....</b>	<b>3</b>
<b>START UP.....</b>	<b>4</b>
<b>GET TO KNOW YOUR FREEZER.....</b>	<b>4</b>
<b>LOVE DIGITAL TEMPERATURE CONTROLLER.....</b>	<b>4-5-6-7-8-9</b>
<b>ALARM SIGNAL SYSTEM.....</b>	<b>4</b>
<b>MAINTENANCE.....</b>	<b>10</b>
<b>TROUBLESHOOTING.....</b>	<b>11-12</b>
<b>WARRANTIES.....</b>	<b>13</b>
<b>WIRING DIAGRAM.....</b>	<b>14</b>

# CONTACTING THE FACTORY

For reference and when contacting the factory, please have your freezer information ready:

**Model Number:**

**Serial Number:**

**Date Received:**



\*The Model Number and Serial Number can be found on the data plate attached to the cabinet on the back upper left corner.

## IMPORTANT...READ FIRST

- Make sure your freezer is placed on a level surface and in a well ventilated room. Provide at least 3" of space around the freezer for ventilation. Avoid placing the freezer in locations exposed to direct sunlight or any heat source.
- Alarm On/Off switch should remain in the "Off" position until freezer reaches desired set point temperature. When the temperature has been reached, turn the alarm switch to the "On" position.
- Freezers are pre-programmed for proper operation.  
\*\*Depending on your specifications, you may need to only adjust the set point.
- Freezer should not be loaded with product until the cabinet has operated for 24 hours at the desired setpoint temperature
- Caution: When skin is exposed to low temperature conditions, frostbite is possible.  
\*\*Please wear proper gear to avoid freezing of exposed skin.
- The outer surface should be kept clean and free of any wrapping, covers or objects that will limit the transfer of the heat from the freezer shell.
- It's recommended to keep the freezer running at a temperature below freezing rather than turning the freezer off and on.
- This freezer is not a \*rapid-freeze\* unit.
- If loading large amounts of product into the freezer at one time, be aware that the inside temperature will increase and may trigger the alarm. (You may turn the alarm off until the unit has fully recovered back to set point temperature)
-

# PRECAUTIONS AND SAFETY

In this manual, the words WARNING and CAUTION mean the following:

- \*  **WARNING** A potentially hazardous situation, which if not avoided, could result in serious injury or death.
- \*  **CAUTION** A potentially hazardous situation, which if not avoided, may result in minor or moderate injury or damage to equipment.

Before installing, using or maintaining this product, please be sure to read this manual carefully. Failure to follow these instructions may cause this product to malfunction, which could result in injury or damage.

Below are important precautions that apply to this product:

- Use this product only in the manner described in this manual. Before using it, verify that this product is suitable for its intended use.
- Do not modify the cabinet by drilling new holes.
- The cabinet must be properly grounded in accordance with the national and local electrical codes and ordinances.
- Disconnect the unit from all power sources before doing any maintenance or cleaning of the unit.
- If you are storing high value product in freezer, it is recommended that an independent monitoring system be used to monitor and alert you of any issues that may interfere with the freezer's operation.
- Do not get temperature controller wet.
- Freezer is not designed for Dry Ice storage
- Room ambient temperature for freezer must be between 15° to 32°C for the freezer to operate properly.

# CHOOSING THE BEST LOCATION

## MOVING YOUR FREEZER:

*The refrigeration system is designed to operate with the cabinet located on a flat surface.*

***\*Do not tilt the cabinet more than 30° to any side.\****

*If the cabinet must be tilted on an angle for handling or moving purposes, allow it to sit in an upright position for at least two (2) hours prior to plugging in and starting the freezer.*

## THE LOCATION:

### Wiring and Installation:

Your freezer is designed for indoor use only. Please confirm your power supply is adequate and delivers the correct voltage requirements for your new freezer. Operating the freezer with insufficient power can result in severe damage to the compressor and electrical components.

~Voltage requirements for your freezer can be found on the serial tag on back upper left side of your cabinet~

115V cabinet is equipped with a Nema 5-15P three-prong plug for your protection against shock hazards.

Choose a location that is close to a dedicated electrical line with a proper grounded (three-prong) electrical outlet.

\*\*230V models do not come with a plug.

**⚠WARNING** \*Do not use an extension cord or surge protector.

**⚠WARNING** \*Do not use an adapter of any sorts.

**⚠WARNING** \*Do not remove or modify the ground pin on the electrical plug.

**⚠WARNING** \*To avoid freezer being shut off....Do not plug freezer into outlet controlled by a wall switch.

**⚠WARNING** \*When unplugging the unit from the wall outlet, never pull on the cord. Always grip the plug safely and pull straight out from the outlet.

### Air Circulation:

The cabinet should be situated in a well ventilated room to allow proper air circulation. Provide at least 3" of space around the entire freezer for ventilation.

\*NOTE: The cabinet must be installed on a sturdy, solid, level floor resting firmly on all four mounting points\*

### Ambient Temperature:

Do not place the freezer in locations exposed to direct sunlight, heat registers or any other heat sources.

Drafts from fans, air conditioning or open doors can also affect the cabinet and product temperature.

The ambient temperature range for the location must be 59° to 90°F ( 15° to 32°C) for optimal freezer performance.

\*When opening the door, avoid leaving it open for extended periods of time. Chamber air will escape rapidly.

Room air, which is higher in humidity, will replace chamber air and may cause frost to develop in the chamber more rapidly

# START UP AND GET TO KNOW YOUR FREEZER

## START UP:

- 1) Turn alarm switch to the off position.
- 2) Plug in or connect freezer power source.
- 3) Confirm or change setpoint temperature (To change setpoint temperature, see below)
- 3) When the setpoint temperature has been reached, turn the alarm switch to the "ON" position.

## Alarm Signal System:

**On start up:** The Alarm should be kept in the "OFF" position until the cabinet set point temperature has been reached. When the temperature has been reached, switch to the "ON" position.

The Alarm system is an audible signal-warning system. When used in conjunction with a SCIENTEMP low temperature cabinet, it will monitor "temperature-rise" only.

## Interior Compartment Temperature:

The temperature is controlled by a LOVE digital temperature controller. Freezers are shipped from the factory with the indicating digital control preprogrammed for proper operation. You may only need to adjust the setpoint temperature.

To change the Setpoint temperature:

Setting SP1 and SP2

- Press and release SET. The current value of order 1 is displayed. SP1 (freezer set point) and led OUT 1 blink.
- Press UP or DOWN to increase or decrease the value.
- Press SET to confirm the new value. The actual value of order 2 will be displayed, SP2 (freezer alarm set point) and LED OUT 2 blink.
- Press UP or DOWN to increase or decrease the value.
- Press SET to confirm the new value and exit.

\*\*Cabinets operate best in ambient temperatures of 59° to 90°F ( 15° to 32°C) for optimal freezer performance.

Note: If freezers are stored in rooms colder than 59°F / 15°C you may get a controller message of "ErP" or "---"  
Controller probes are accurate to -50°C (-58°F)

# LOVE TSS2 Control Configuration

\*\*This information is for informational purposes only. Your controller has been preprogrammed with the values shown.

<u>LOVE TSS2 CONTROL CONFIGURATION</u>	<u>UNITS</u>	<u>VALUE</u>
SP1-SET POINT 1 (FREEZER TEMPERATURE)	DEGREES	-30
SP2-SET POINT 2 (ALARM SET POINT TEMPERATURE)	DEGREES	-24
RO-DEPENDENCY SP1,SP2	RANGE	IND
R1-DIFFERENTIAL FOR SP1	DEGREES	0.2
R2-DIFFERENTIAL FOR SP2	DEGREES	0.2
R3-BAND DIFFERENTIAL	DEGREES	0.2
R4-LOWEST VALUE FOR SP1	DEGREES	-99.9
R5-LOWEST VALUE FOR SP2	DEGREES	-99.9
R6-HIGHEST VALUE FOR SP1	DEGREES	99.9
R7-HIGHEST VALUE FOR SP2	DEGREES	99.9
R8-REGULATION OR OPERATING MODE	RANGE	ON1
A0-ALARM DIFFERENTIAL	DEGREES	0.3
A1- MAXIMUM ALARM PROBE 1	DEGREES	99.9
A2-MAXIMUM ALARM PROBE 2	DEGREES	99.9
A3-MINIMUM ALARM PROBE 1	DEGREES	99.9
A4-MINIMUM ALARM PROBE 2	DEGREES	99.9
A5-ALARM VERIFICATION TIME	H-M	0.1
C0-MINIMUM RELAY STOP TIME	MINUTES	0
C1-OPERATION RELAY 1	RANGE	DIR
C2-OPERATION RELAY 2	RANGE	DIR
C3- DEFAULT OPERATION RELAY 1	RANGE	CLO
C4-DEFAULT OPERATION RELAY 2	RANGE	CLO
P0-TEMPERATURE SCALE SELECTION	RANGE	C
P1- CALIBRATION OF PROBE 1	DEGREES	-1.5
P2-CALIBRATION OF PROBE 2	DEGREES	-1.5
P3-DECIMAL POINT	RANGE	YES
P4-PROBE TO BE DISPLAYED	RANGE	SD1
P5-NUMBER OF PROBES	RANGE	2
H0-REPROGRAMMING	RANGE	0
H1-KEYBOARD PROTECTION	RANGE	NO
H2-OPERATION LED OUT1	RANGE	DIR
H3-OPERATION LED OUT2	RANGE	DIR
H4-ADDRESS FOR SERIAL COMMUNICATION	NUMERIC	0
H5-ACCESS CODE TO PARAMETERS	NUMERIC	0

## SETTING SP1 (TEMPERATURE SET POINT) AND SP2 (ALARM SET POINT)

PRESS AND RELEASE **SET**. THE CURRENT VALUE OF **SP 1** IS DISPLAYED.

**SP1** AND OUT 1 BLINK. PRESS UP OR DOWN TO INCREASE OR DECREASE THE VALUE.

PRESS **SET** TO CONFIRM THE NEW VALUE. THE ACTUAL VALUE OF **SP 2** IS DISPLAYED.

**SP2** AND **OUT 2** WILL BLINK. PRESS **UP** OR **DOWN** TO INCREASE OR DECREASE THE VALUE.

PRESS **SET** TO CONFIRM THE VALUE AND EXIT.

## PARAMETER SETUP

PRESS **SET** FOR 8 SECONDS. VALUE 0 BLINK.

WITH **UP** OR **DOWN** INPUT ACCESS CODE ( FACTORY SET AS 0).

PRESS **SET** TO CONFIRM THE CODE. IF CORRECT THE, LABEL OF THE FIRST

PARAMETER WILL BE DISPLAYED. PRESS **UP** OR **DOWN** TO VIEW THE PARAMETER

FROM THE LIST. PRESS **SET** TO VIEW THE PARAMETER VALUE. PRESS **UP** OR **DOWN** TO

CHANGE THE VALUE. PRESS **SET** TO CONFIRM AND EXIT TO THE PARAMETER LIST.

PRESS **SET + DOWN** TO EXIT SETUP MODE OR WAIT ONE MINUTE.



## Series TSS2 Dual Stage Temperature Switch

### Specifications - Installation and Operating Instructions

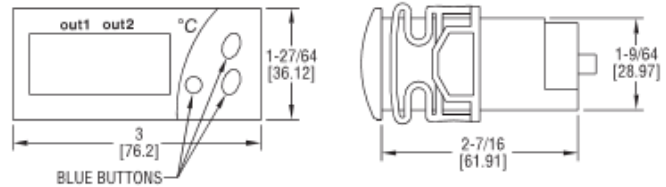

WIRING DIAGRAM

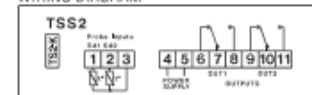

The **TSS2** is an electronic temperature controller designed for ON/OFF control or Neutral Area Control. They can be provided with 1 or 2 probes (PTC or NTC) according to parameter P5 and it provides two output relays plus an alarm buzzer. The unit controls cooling, heating or both, since its relays can be setup for direct or reverse operation. The user is able to program 34 different parameters including set points, hysteresis, configuration of alarms and probe adjustment using the silicone front keypad. The unit features error warning and password protection.

Each suffix can take the following values:

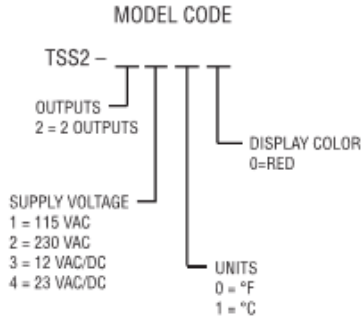

**Note:** Unit must be mounted away from vibration, impacts, water and corrosive gases.

- Cut hole in panel 71 x 29 mm (2.80 x 1.14 inches).
- Apply silicone (or rubber gasket) around the perimeter of the hole to prevent leakage.
- Insert unit into hole of panel.
- Slide removable fitting clips onto unit from the back until secure to panel.
- Wiring diagram is displayed on the top of the unit.
- **Note:** DO NOT INSTALL PROBE CABLE NEAR POWER CABLES.

#### SPECIFICATIONS

##### Probe Range:

- PTC: -58 to 302°F (-50 to 150°C);
- NTC: -58 to 230°F (-50 to 110°C).

##### Input:

- PTC: 1000Ω @ 25°C;
- NTC: 10 kΩ @ 25°C.

**Outputs:** OUT1 - SPDT relay rated 16A @ 240 VAC resistive; OUT2 - SPDT relay rated 8A @ 240 VAC resistive.

**Horsepower Rating (HP):** 1 HP (OUT1).

**Power Requirements:** 115 VAC, 230 VAC, 12 VAC/VDC or 24 VAC/VDC (depending on model).

**Accuracy:** 1% FS.

**Display:** 3-digit and sign, red LED.

**Resolution:** 0.1° (<100°); 1° (≥100°).

**Memory Backup:** Nonvolatile memory.

**Temperature Limit:** Ambient: 32 to 158°F (0 to 70°C).

**Storage Temperature:** -4 to 176°F (-20 to 80°C).

**Dimensions:** 3 x 1-27/64 x 2-7/16 in.

**Front Panel Rating:** IP64.

**Weight:** 2.3 oz (65 g).

**Agency Approvals:** CE, cURus.

#### Maintenance, cleaning and repair

After final installation of the unit, no routine maintenance is required. Clean the surface of the display controller with a soft and damp cloth. Never use abrasive detergents, petrol, alcohol or solvents. All repairs must be made by authorized personnel.

**LOVE CONTROLS DIVISION**  
**DWYER INSTRUMENTS INC.**  
 P.O. BOX 338 - MICHIGAN CITY, INDIANA 46360, U.S.A.

Phone: 219/879-8000 [www.love-controls.com](http://www.love-controls.com)  
 Fax: 219/872-9057 e-mail: [love@love-controls.com](mailto:love@love-controls.com)

**List of parameters**

	Description	Units	Range
SP1	Set Point 1	Degrees	r4 to r6
SP2	Set Point 2	Degrees	r5 to r7
r0	Dependency SP1-SP2	Range	ind/dep
r1	Differential for SP1	Degrees	0.1 to 20.0
r2	Differential for SP2	Degrees	0.1 to 20.0
r3	Band differential	Degrees	0.1 to 20.0
r4	Lowest value for SP1	Degrees	-99.9 to r6
r5	Lowest value for SP2	Degrees	-99.9 to r7
r6	Highest value for SP1	Degrees	r4 to 302
r7	Highest value for SP2	Degrees	r5 to 302
r8	Regulation or operating mode	Range	On1/On2/nEU
A0	Alarm differential	Degrees	0.1 to 20.0
A1	Maximum alarm probe 1 (1)	Degrees	0.1 to 99.9
A2	Maximum alarm probe 2 (2)	Degrees	0.1 to 99.9
A3	Minimum alarm probe 1 (1)	Degrees	0.1 to 99.9
A4	Minimum alarm probe 2 (2)	Degrees	0.1 to 99.9
A5	Alarm verification time	h-m (*)	0.0 to 18.0
A6	Alarm probe 1 selection	Range	AHL/Ano/AH/AL
A7	Alarm probe 2 selection	Range	AHL/Ano/AH/AL
c0	Minimum relay stop time	Minutes	0 to 240
c1	Operation relay 1	Range	dir/inv
c2	Operation relay 2	Range	dir/inv
c3	Default operation relay 1	Range	Opn/Clo
c4	Default operation relay 2	Range	Opn/Clo
P0	Temperature scale selection	Range	°C/°F
P1	Calibration of probe 1	Degrees	-20.0 to 20.0
P2	Calibration of probe 2	Degrees	-20.0 to 20.0
P3	Decimal point	Range	no/yes
P4	Probe to be displayed	Range	sd1/sd2
P5	Number of probes	Range	1/2
H0	Reprogramming	Range	0
H1	Keyboard protection	Range	no/yes
H2	Operation LED OUT1	Range	dir/inv
H3	Operation LED OUT2	Range	dir/inv
H4	Address for serial communication	Numeric	0 to 999
H5	Access code to parameters	Numeric	0 to 999
H6	Probe type	Range	Ptc/Ntc

(\*)h-m are data in format XX.Y where XX are hours and Y tens of minutes.

(1)referred to set 1.

(2)referred to set 2.

**Parameter descriptions**

**SP1** = Operation order of relay 1. Specifies the ON/OFF point of relay 1. Variable between r4 and r6.

**SP2** = Operation order of relay 2. Specifies the ON/OFF point of relay 2. Variable between r5 and r7.

**r0** = Dependency between SP1 and SP2. Only for mode ONOFF1

ind = order for relay 2, SP2.

dep = order for relay 2, SP1+SP2.

**r1** = Differential or hysteresis for relay 1. Temperature differential between ON/OFF of relay 1 in ON/OFF control.

**r2** = Differential or hysteresis for relay 2. Temperature differential between ON/OFF of relay 2 in ON/OFF control.

**r3** = Band differential. Temperature differential between ON/OFF of relays 1 and 2 in neutral area control. For relay 1 it is added to SP1 and for relay 2 it is subtracted from SP1.

**r4** = Lowest value for SP1.

**r5** = Lowest value for SP2.

**r6** = Highest value for SP1.

**r7** = Highest value for SP2.

**r8** = Regulation or operating mode. Selection of the operating mode.

**A0** = Alarm differential. It is the temperature differential between the alarm On and Off cycle.

**A1** = Maximum alarm probe1.

**A2** = Maximum alarm probe2.

Maximum alarm ON when probe 2 higher than SP2+A2

Maximum alarm OFF when probe 2 lower than SP2+A2-A0.

**A3** = Minimum alarm probe1.

Minimum alarm ON when probe 1 lower than SP1-A3

Minimum alarm OFF when probe 1 higher than SP1-A3+A0.

**A4** = Minimum alarm probe2.

Minimum alarm ON when probe 2 lower than SP2-A4

Minimum alarm OFF when probe 2 higher than SP2-A4+A0.

**A5** = Alarm verification time. Time from the alarm event until it trips.

**A6** = Alarm probe 1 selection.

AHL=Maximum and minimum alarm probe 1 enabled.

Ano=No alarms probe 1.

AH=Maximum alarm probe 1 enabled.

AL=Minimum alarm probe 1 enabled.

**A7** = Alarm probe 2 selection.

AHL=Maximum and minimum alarm probe 2 enabled.

Ano=No alarms probe 2.

AH=Maximum alarm probe 2 enabled.

AL=Minimum alarm probe 2 enabled.

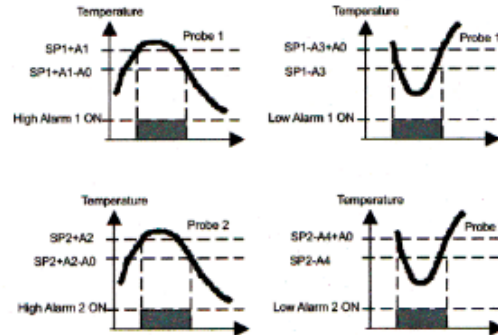

**c0** = Minimum relay stop time. Minimum time from the disconnection of a relay until it can be switched on again.

**c1** = Operation relay 1. Selection between direct or reverse operation for relay 1.

**c2** = Operation relay 2. Selection between direct or reverse operation for relay 2.

**c3** = Default operation relay 1. In case of failure of probe 1:

oPn= relay 1 will remain open.

Clo= relay 1 will remain closed.

**c4** = Default operation relay 2. In case of failure of probe 1 (for all modes excepting ON OFF2) or in case of failure of probe 2 (for mode ON OFF2):

oPn= relay 2 will remain open.

Clo= relay 2 will remain closed.

**P0** = Temperature scale selection.

**P1** = Calibration of probe 1. Offset degrees to be added to probe 1.

**P2** = Calibration of probe 2. Offset degrees to be added to probe 2.

**P3** = Decimal point. If the displayed value of the probes is desired with decimals or not.

**P4** = Probe to be displayed. Probe always on the display. The other probe can be seen pressing the keys SET+UP.

sd1= probe 1.

sd2= probe 2.

**P5** = Number of probes. If P5=1, there is not ON OFF2 mode. If selected, it will operate as ONOFF1.

**H0** = Reprogramming. Parameter to reprogram the thermostat.

**H1** = Keyboard protection.

To change the sets, enter into parameter and exit again. The protection setting is momentarily released. It switches on again 1 minute after the last time a key was pressed.

Yes= Keyboard Protected.

No=Keyboard non protected.

**H2** = Operation of LED OUT1.

dir = On when relay 1 is ON.

inv = On when relay 1 is OFF.

**H3** = Operation of LED OUT2.

dir = On when relay 2 is ON.

inv = On when relay 2 is OFF.

**H4** = Serial communication address. Address for computer connection.

**H5** = Parameter entry code. Factory set as 0.

**H6** = Input probe type selectable between PTC or NTC.

### Message display

Under normal operation, the temperature of the probe selected by P4 will be displayed, the following messages may also appear:

- Err** Memory reading error.
- ErP** Error of the probe not shown on the display.
- AH1** Maximum temperature alarm, probe 1.
- AL1** Minimum temperature alarm, probe 1.
- AH2** Maximum temperature alarm, probe 2.
- AL2** Minimum temperature alarm, probe 2.
- ooo** Open probe.
- **---** Shorted probe.

Pressing SET with UP it displays the probe not selected by P4.

When the probe not selected by P4 is displayed, it alternates its value with message Sd1 or Sd2 depending if it is probe 1 or probe 2.

The display blinks when waiting for a value confirmation.

### LED indications

**Out1:** Indicates relay 1 On or Off as per parameter H2. If H2=dir, with relay 1 On, LED lit, if H2=inv, with relay 1 On, LED off. It blinks when SP1 is displayed.

**Out2:** Indicates relay 2 On or Off as per parameter H3. If H3=dir, with relay 2 On, LED lit, if H3=inv, with relay 2 On, LED off. It blinks when SP2 is displayed.

### Setting SP1 and SP2

- Press and release SET. The current value of order 1 is displayed. SP1 and led OUT1 blink.
- Press UP or DOWN to increase or decrease the value.
- Press SET to confirm the new value. The actual value of order 2 will be displayed, SP2 and LED OUT2 blink.
- Press UP or DOWN to increase or decrease the value.
- Press SET to confirm the new value and exit.

### Parameter setup

- Press SET for 8 seconds. Value 0 will blink.
- With UP and DOWN input the code (factory set as 0).
- Press SET to confirm the code. If correct, the label of the first parameter will be displayed.
- With UP or DOWN go to the desired parameter in the parameter list.
- Press SET to see the value.
- With UP or DOWN change the value to the new value as desired.
- Press SET to confirm and exit again to the parameter list. (Also to exit to the list without parameter modification.)
- Press SET + DOWN to exit setup or wait for 1 minute.

### Resetting the keyboard code

You can setup to 0 the keyboard code switching the unit off and on while pressing the SET key.

### Buzzer disconnection

Pressing SET with DOWN turns off the buzzer alarm. The message of alarm continue appearing in the display.

### Reprogramming factory values (H0)

- Access to parameter H0 as explained in parameter setup.
- Value 0 will be displayed.
- Press SET for 8 seconds. Pro will be displayed if they have been setup correctly.
- Press SET + DOWN to exit setup or wait for 1 minute.

	Description	Factory value
SP1	Set Point 1	10.0
SP2	Set Point 2	10.0
r0	Dependency SP1 - SP2	ind
r1	Differential for SP1	1.0
r2	Differential for SP2	1.0
r3	Band differential 1.0	1.0
r4	Lower value for SP1	-99.9
r5	Lower value for SP2	-99.9
r6	Higher value for SP1	99.9
r7	Higher value for SP2	99.9
r8	Regulation or operating mode	On1
A0	Alarm differential	0.1
A1	Maximum alarm probe 1	99.9
A2	Maximum alarm probe 2	99.9
A3	Minimum alarm probe 1	99.9
A4	Minimum alarm probe 2	99.9
A5	Alarm verification time	18.0
A6	Alarm probe 1 selection	AHL
A7	Alarm probe 2 selection	AHL
c0	Minimum relay stop time	0
c1	Operation relay 1	dir
c2	Operation relay 2	dir
c3	Default operation relay 1	Opn
c4	Default operation relay 2	Opn
P0	Temperature scale selection	°C
P1	Calibration of probe 1	0.0
P2	Calibration of probe 2	0.0
P3	Decimal point	yes
P4	Probe to be displayed	sd1
P5	Number of probes	2
H0	Reprogramming	0
H1	Keyboard protection	no
H2	Operation LED OUT1	dir
H3	Operation LED OUT2	dir
H4	Address for serial communication	0
H5	Access code to parameters	0
H6	Probe type	Ptc

**Operating modes**

**Mode ON OFF1 (On1) with r0=ind.**

Relay 1 with c1=dir.

Temperature of probe 1  $\geq$  SP1+r1 -->relay 1 ON  
 Temperature of probe 1  $\leq$  SP1 -->relay 1 OFF

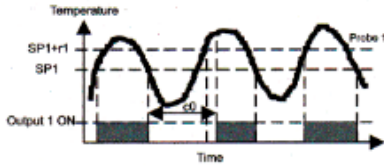

Figure 1

Relay 1 with c1=inv.

Temperature of probe 1  $\leq$  SP1-r1 -->relay 1 ON  
 Temperature of probe 1  $\geq$  SP1 -->relay 1 OFF

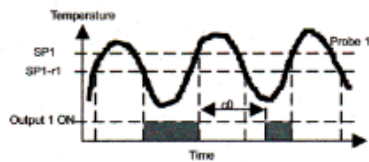

Figure 2

Relay 2 with c2=dir.

Temperature of probe 1  $\geq$  SP2+r2 -->relay 2 ON  
 Temperature of probe 1  $\leq$  SP2 -->relay 2 OFF

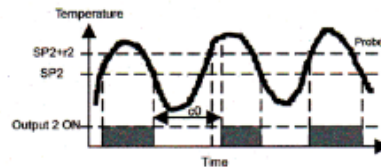

Figure 3

Relay 2 with c2=inv.

Temperature of probe 1  $\leq$  SP2-r2 -->relay 2 ON  
 Temperature of probe 1  $\geq$  SP2 -->relay 2 OFF

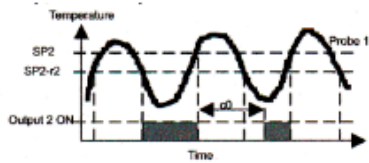

Figure 4

**Mode ON OFF1 (On1) with r0=dep.**

Output 1 works as in independent ON/OFF control (Figure 1 and 2), but output 2 works as follows:

Relay 2 with c2=dir.

Temperature of probe 1  $\geq$  SP1+SP2+r2 -->relay 2 ON  
 Temperature of probe 1  $\leq$  SP1+SP2 -->relay 2 OFF

Relay 2 with c2=inv.

Temperature of probe 1  $\leq$  SP1+SP2-r2 -->relay 2 ON  
 Temperature of probe 1  $\geq$  SP1+SP2 -->relay 2 OFF

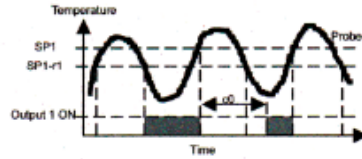

Figure 2

**Mode ON OFF2 (On2)**

Output 1 works as in independent ON/OFF control (Figure 1 and 2), but output 2 works as follows:

Relay 2 with c2=dir.

Temperature of probe 2  $\geq$  SP2+r2 -->relay 2 ON  
 Temperature of probe 2  $\leq$  SP2 -->relay 2 OFF

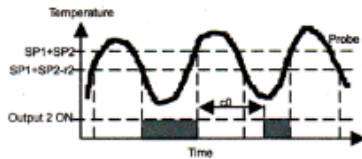

Figure 6

Relay 2 with c2=inv.

Temperature of probe 2  $\leq$  SP2-r2 -->relay 2 ON  
 Temperature of probe 2  $\geq$  SP2 -->relay 2 OFF

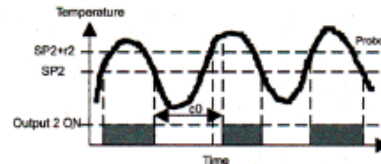

Figure 7

**Neutral Area Mode (nEU)**

Relay 1

Temperature of probe 1  $\geq$  SP1+r3 -->relay 2 ON  
 Temperature of probe 1  $\leq$  SP1 -->relay 2 OFF

Relay 2

Temperature of probe 1  $\leq$  SP1-r3 -->relay 2 ON  
 Temperature of probe 1  $\geq$  SP1 -->relay 2 OFF

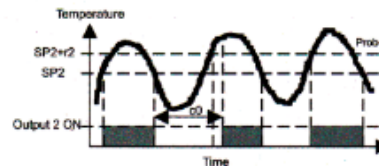



Figure 7

**Operation in case of error.**

If probe 1 fails, the operation is through c3. (See Parameter description.)  
 If probe 2 fails, the operation is through c4. (See Parameter description.)  
 In case of memory failure, both relays will remain open.

# MAINTENANCE

\*  **CAUTION** Maintenance or repair of your freezer should only be performed by a trained professional.

\*The refrigeration system is hermetically sealed and the fan motor has lifetime lubrication, they requires no maintenance.

~It's recommended to keep the freezer operating at a temperature below freezing rather than turning the freezer off and on.

## **CLEANING THE CONDENSER:**

(If equipped) The black wire on tube condenser on the back of the freezer near the refrigeration compartment of the freezer, should be cleaned of dust and debris about once a year (or more often if the freezer is located where excessive dust and dirt may occur)

To clean the condenser:

- Remove power to freezer.
- Locate the wire condenser on back of freezer.
- Use forced air and a vacuum to clean dirt/debris from the condenser and refrigeration compartment.

## **DEFROSTING THE FREEZER:**

Defrosting: Accumulation of frost may be removed in a couple of ways.

1.) While the freezer is running the frost may be removed with a plastic or wooden scraper or spatula, do not use metal or sharp objects such as an ice pick. This will prevent serious damage to the finish of the inner-liner of the freezer. The frost and ice may be collected in a pan, towel or any device to prevent it from falling to the bottom of the freezer or onto the material stored in the freezer.

Most of the frost and ice collects near the top edge and is easily removed.

2.) In the case where the freezer is not loaded, frost and ice may be removed by disconnecting the power the power until the frost and ice thaw. After defrosting, dry the freezer compartment interior and plug back in. \*\*To help with the defrosting procedure, open lid to allow warm air inside the chamber.

## **MAINTENANCE FOR THE LID GASKET:**

Occasionally check and make sure there is no frost or ice build up on or around the gasket. Keeping the gasket clean and free of ice and frost will help prevent the gasket from getting torn or punctured.

Make sure the gasket is completely connected on all sides and laying flush to the lid.

## **CLEANING THE EXTERIOR AND INTERIOR:**

As needed: Use only a soft cloth and mild cleaners. Do not use harsh solvents or abrasives to clean the interior or exterior of the freezer.

# TROUBLESHOOTING GUIDE

PROBLEM	POSSIBLE CAUSE	SOLUTION
Freezer does not power up / no digital display	1. Freezer not plugged into power supply	1. Plug freezer into dedicated power source (wall outlet)
	2. Power cord not firmly seated in power outlet.	2. Push plug firmly into outlet
	3. No power at outlet	3. Move freezer to different outlet or try plugging something else into outlet to test the outlet.
	4. Fuse Blown or Circuit Breaker tripped	4. Check breaker/ fuse box and make sure that it's not tripped or have blown fuse.
	5. Make sure you have correct voltage at outlet	5. Contact service technician
Freezer is not cooling / Digital Display is on	1. Compressor not running	1. Possibly bad compressor or compressor start components. (Contact service technician)
	2. Possible leak or no refrigerant	2. Contact service technician
	3. Check voltage	3. Make sure there is proper voltage at outlet. (Contact service technician)
	4. Check for proper controller settings	See "LOVE Configuration Data" for proper settings
Temperature inside freezer does not reach the desired setpoint temperature / recovers slowly	1. Condenser coils are plugged or dirty	1. Contact service technician to properly clean coil
	2. Freezer Gasket is dirty or damaged	2. Clean or replace the bad gasket
	3. Ambient temperature is too warm	3. Cool location down and keep away from heat source
	4. Large amounts of warm product was added or too much product	4. Allow Freezer to recover after loading with warm product.
	5. Door may be opened to frequently	5. Warm air entering freezer will cause the freezer to warm up.
	6. Not enough air circulating around freezer	6. Make sure there is at least 3" of space around the outside of the freezer.
	7. Make sure condenser fan motor is operating/spinning in refrigeration compartment.	7. If fan motor is not spinning, determine the reason and fix.
Freezer too cold	1. Controller is set too cold	1. Change temperature
	2. Power relay is faulty	2. Contact service technician
External surface of freezer is warm/hot to touch	1. Warmer than room temperature	1. This is normal at start up. Freezer compressor(s) transfers heat from inside the unit to the outside, through the walls.
Excessive frost build up	1. Hot and humid air	1. This is normal.
	2. Door opened frequently or long periods of time	2. Keeping door closed helps with frost build up.
	3. Door may not be sealing correctly	3. Check gasket area for frost build up. Remove any frost and keep gasket clean. *Also check for damage to the ~ Make sure the lid is flat and seal is seated correctly
Door will not close	1. Excessive frost build up	1. Using a wood scraper carefully remove excessive frost
	2. Hinges	2. Hinges need adjusting (* See "Hinges") for instructions



# US / CANADA WARRANTY



## Scientemp

3565 S. Adrian Hwy ♦ Adrian, MI 49221  
800-968-2653 ♦ 517-263-6020 ♦ Fax 517-263-5492

### **Standard Warranty**

**Applies Only Within United States and Canada**

#### **SCIENTEMP WARRANTS TO THE ORIGINAL PURCHASER**

**FIRST 18 MONTHS** – The cabinet and all of its parts, shall be free of defects in material and workmanship under normal use and service for a period of 18 months from the date the unit has been shipped from our facility. Scientemp's sole obligation under this warranty shall be limited, at its option, to either repairing or replacing any part of the cabinet determined by an authorized service agent to be defective. Scientemp reserves the right to repair the freezer at our facilities.

#### **THE SCIENTEMP STANDARD WARRANTY DOES NOT COVER**

**TRANSPORTATION COSTS** – Scientemp shall not be responsible for transportation or incidental costs incurred in connection with the repair or replacement of a cabinet or any of its parts.

**ABUSE, MISUSE, ACCIDENTS** – Scientemp shall not be responsible for parts or assemblies which upon inspection are determined by an authorized Scientemp Service Agent to have been subjected to misuse, neglect, alteration, accident, abuse, damage during transit or delivery, or by fire or flood.

**CONSEQUENTIAL DAMAGES – IN NO EVENT SHALL SCIENTEMP CORP BE LIABLE FOR SPECIAL, INDIRECT OR CONSEQUENTIAL DAMAGES, INCLUDING WITHOUT LIMITATION, PRODUCT LOSS OR PRODUCT SPOILAGE CLAIMS, NOR FOR ANY DELAY IN THE PERFORMANCE OF THIS WARRANTY DUE TO CAUSES BEYOND ITS CONTROL.**

#### **GENERAL**

The standard warranty and any service contract related to the STANDARD WARRANTY shall apply only to the products sold and used within the boundaries of the United States and Canada.

Users may file warranty claims either directly with Scientemp Corp, 3565 S. Adrian Hwy, Adrian, MI 49221, or with the seller from whom the cabinet was purchased. All claims must be supported by information concerning the alleged defect and specifically identified by the Serial Number of the cabinet.

**THERE ARE NO OTHER WARRANTIES EXPRESS, IMPLIED, OR STATUTORY, EXCEPT THIS WARRANTY, WHICH IS IN LIEU OF ALL OTHER WARRANTIES INCLUDING TO THE EXTENT PERMITTED BY LAW, ANY IMPLIED WARRANTY OR MERCHANTABILITY OR FITNESS FOR A PARTICULAR PURPOSE.**

#### **DO NOT DRILL HOLES IN CABINET**

Refrigeration tubing and wiring is routed through the cabinet walls. Leaks, wet insulation or electrical problems caused by drilling holes are not covered by warranty.

# INTERNATIONAL WARRANTY



## Scientemp™

3565 S. Adrian Hwy ♦ Adrian, MI 49221  
800-968-2653 ♦ 517-263-6020 ♦ Fax 517-263-5492

### **International Warranty**

#### **SCIENTEMP WARRANTS TO THE ORIGINAL PURCHASER**

**FIRST 18 MONTHS** – The cabinet and all of its parts shall be free of defects in material and workmanship under normal use and service for a period of 18 months from the date the unit has been shipped from our facility. Under this warranty, Scientemp will supply replacement parts, F.O.B. Adrian, Michigan, U.S.A., for any part proven defective in material and workmanship. Scientemp is not responsible for supplying the labor required to replace parts and make necessary repairs.

#### **THE SCIENTEMP STANDARD WARRANTY DOES NOT COVER**

**TRANSPORTATION COSTS** – Scientemp shall not be responsible for transportation or incidental costs incurred in connection with the repair or replacement of a cabinet or any of its parts.

**ABUSE, MISUSE, ACCIDENTS** – Scientemp shall not be responsible for parts or assemblies which upon inspection are determined by an authorized Scientemp Service Agent to have been subjected to misuse, neglect, alteration, accident, abuse, damage during transit or delivery, or by fire or flood.

**CONSEQUENTIAL DAMAGES – IN NO EVENT SHALL SCIENTEMP CORP BE LIABLE FOR SPECIAL, INDIRECT OR CONSEQUENTIAL DAMAGES, INCLUDING WITHOUT LIMITATION, PRODUCT LOSS OR PRODUCT SPOILAGE CLAIMS, NOR FOR ANY DELAY IN THE PERFORMANCE OF THIS WARRANTY DUE TO CAUSES BEYOND ITS CONTROL.**

#### **GENERAL**

The standard warranty and any service contract related to the STANDARD WARRANTY shall apply only to the products sold and used outside the boundaries of the Continental United States.

Users may file warranty claims either directly with Scientemp Corp, 3565 S. Adrian Hwy, Adrian, MI 49221, or with the seller from whom the cabinet was purchased. All claims must be supported by information concerning the alleged defect and specifically identified by the Serial Number of the cabinet.

**THERE ARE NO OTHER WARRANTIES EXPRESS, IMPLIED, OR STATUTORY, EXCEPT THIS WARRANTY, WHICH IS IN LIEU OF ALL OTHER WARRANTIES INCLUDING TO THE EXTENT PERMITTED BY LAW, ANY IMPLIED WARRANTY OR MERCHANTABILITY OR FITNESS FOR A PARTICULAR PURPOSE.**

#### **DO NOT DRILL HOLES IN CABINET**

Refrigeration tubing and wiring is routed through the cabinet walls. Leaks, wet insulation or electrical problems caused by drilling holes are not covered by warranty.

# MODERATE WIRING DIAGRAM

