

Scientemp Corp.

3565 S. Adrian Hwy
Adrian, Michigan 49221

Phone: 517-263-6020

Fax: 517-263-5492

Website: www.scientemp.com

OPERATING AND INSTALLATION MANUAL MODEL 34-15A

This cabinet has passed the
QUALITY CONTROL INSPECTION
and meets the high standards at Scientemp Corp.
This inspection includes the complete refrigeration
system, cabinet construction and finish.

ABOUT YOUR SCIENTEMP FREEZER

Your freezer is best located in a well-ventilated room. Provide a small space around the freezer for ventilation. The condenser of the freezer is located on the insulation side of the outer case. Therefore, during operation the outer case (or shell) will feel warm to the touch. From this shell condenser the heat removed from inside the freezer radiates from the case and is dispersed into the air. For this reason the outer surface should be kept reasonably clean and free of any wrapping, covers or objects that will limit the dispersing of the heat from the freezer shell. Avoid placing the freezer in locations exposed to direct sun light, heat registers or other heat sources.

The refrigeration system of a Scientemp freezer is hermetically sealed. It requires no maintenance. However, in areas where excessive dust and or dirt collect, it will help to vacuum or blow off the dust or dirt in the unit compartment periodically.

The fan motor has lifetime lubrication. It requires no maintenance.

Defrosting: Accumulation of frost may be removed in a couple of ways.

- 1.) While the freezer is running the frost may be removed with a plastic or wooden scraper or spatula, do not use metal or sharp objects such as an ice pick. This will prevent serious damage to the finish of the inner-liner of the freezer. The frost and ice may be collected in a pan, towel or any device to prevent it from falling to the bottom of the freezer or onto the material stored in the freezer. Most of the frost and ice collects near the top edge and is easily removed.
- 2.) In the case where the freezer is not loaded, frost and ice may be removed by disconnecting the power until the frost and ice thaw. After defrosting, dry the freezer compartment interior and turn on the power.

Freezers are shipped from the factory with the indicating digital control programmed for proper operation. All but the temperature settings are locked-out to avoid misuse. Operating temperature settings may be adjusted. The temperature sensor is a type "T" thermocouple located on the front wall of the inner-liner.

It is recommended to keep the freezer operating at a temperature below freezing rather than turning the freezer off and on.

CAUTION

CAUTION

Using Your Low Temperature Freezer

Any temperature below 0 deg Centigrade or 32 deg Fahrenheit provides a potential condition to cause freezing of water or material containing water. Material containing water solutions of sodium (salt) or sugar will freeze at slightly lower temperature, depending on the content of the solution.

Because all warm-blooded creatures are composed of a great percent of water with salinity, they are subject to freezing whenever the body cells, parts or extremities reach temperatures below freezing. Therefore, it behooves the use of caution whenever you use a freezer or handle a frozen product that is at temperatures below 0 deg Centigrade or 32 deg Fahrenheit.

When skin freezes

When your skin is exposed to subfreezing temperatures for an extended amount of time, it can freeze. Your blood vessels constrict in response to dropping temperatures. This reduces the flow of blood and, therefore, the amount of oxygen to the tissues. When water in these tissues freezes and forms ice crystals, cell structure is destroyed.

Tissue damage from cell death interrupts circulation in the smallest blood vessels. Blood clots form and blood flow is further diverted away from the frozen tissue. At this point, your skin temperature drops and the injured area grows even colder.

The first sign of frostbite may be a slightly painful tingling sensation, which often is followed by numbness. Your skin may look pale, and feel hard, cold and numb.

In the event of frost bite, re-warming is vital. Carefully and gradually re-warm frostbitten areas. Place your hands directly on the skin of warmer areas of your body. If possible, immerse your hands in water that is slightly above normal body temperature (about 100 F or 37.8 C), or which feels warm to someone else, until your normal color returns. Do not use direct heat. Seek medical attention as quickly as you can.

After thawing

Frostbitten areas will turn red and throb, or burn with pain, as they thaw. Even with mild frostbite, normal sensation may not return immediately. When frostbite is severe, the area will probably remain numb until it heals completely.

Severe frostbite damages nerves and can permanently change your sense of touch in the affected area.

Caution: Use protective clothing when contacting the inside of a freezer or products stored in a freezer. Hands should be dry and protected by using gloves. Insulated gloves are best for extended use when handling frozen product. Arms should be protected by sleeves or arm-length insulated gloves. Other parts of the body that may be exposed to the cold should be protected by coats, insulated aprons, etc.

Frozen packages are hard and often slippery, therefore foot protection should be considered such as hard-toed shoes or foot guards in the event that a package would be dropped.

Your freezer must be electrically grounded to prevent electric shock.

Provide a space around the freezer for ventilation.

INSTALLATION & OPERATION
OF
SCIENTEMP MODERATE LOW COLD CABINETS

MODELS 34-05, 34-07, 34-09, 34-15, 34-20, & 34-25

Scientemp Corp., and its management are dedicated to the production of the most dependable and serviceable product in the industry. The instructions are intended to assist in obtaining the optimum performance from your low temp freezer.

LOCATION: The cabinet should be placed in a location where the air will circulate around the outer case. A minimum of a 2" clearance is recommended for proper air circulation. The unit should rest firmly on all four mounting points.

ELECTRICAL CONNECTION: Electrical connection should be made in compliance with local codes. We suggest a separate circuit with a fused disconnect be installed. To avoid the possibility of an accidental disconnect you may want to consider a direct connection to the electrical source. No less than a No. 14 gauge wire should be used for the electrical connection. (Countries outside the US are not supplied with an electric cord. Follow your country's electric codes.)

LID SEAL: If the lid gasket does not seal along the front edge, relieve the compression of the gasket along the back edge by loosening the hinge screws where they attach to the cabinet. Raise the lid slightly and then retighten the screws.

THE SUB LID: These lids are for the protection of your materials and should be used in place.

SERVICE INSTRUCTION: If the cabinet is not operating properly, we recommend that you have a qualified refrigeration service man check it to analyze the problem. In case of major difficulties, the factory may be contacted before repair is started. In all contacts with the factory, give the model and serial number.

REFRIGERATION SYSTEM

- **REFRIGERATION SYSTEM**

The refrigeration system consists of a hermetically sealed compressor, cold wall evaporator and shell condenser.

- **DRIER**

The drier is installed in the system just before the capillary tube. Its purpose is to trap minute particles of foreign material and absorb any moisture in the system.

- **LIQUID CONTROL AND HEAT EXCHANGE**

Liquid refrigerant control to the evaporator of the system is accomplished by the use of a capillary tube. This capillary tube is soldered to the suction line to form a heat exchanger, which sub cools the liquid refrigerant to maintain high efficiency within the system.

- **REFRIGERATION SERVICE EVACUATION**

Moisture in a refrigeration system is directly or indirectly the cause of more problems and complaints than all other factors combined. When large amounts are present, system freeze ups will occur. Even in minute amounts, moisture will combine with refrigerants to form an acid. The corrosive action of this acid forms sludge which will plug the lines and the drier. Since most field type vacuum pumps cannot pull a low enough vacuum to remove moisture from the system, it is recommended that the system be triple evacuated, breaking each time with dry refrigerant. Use care to purge the air from the system

- **CHARGING REFRIGERATION SYSTEM**

Since capillary tube systems have small critical refrigerant charges, we recommend that a field charge either be weighed in or put in from a portable charge cylinder. After maximum vacuum has been obtained as detailed above, attach charging cylinder to the suction line making sure to purge air from hose with refrigerant. With the unit running, allow refrigerant to run slowly into the system until the desired charge is reached.

OVERCHARGE: When the cabinet has pulled down to operating temperature an indication of an overcharge is that the suction line will be cooler than normal with the compressor running. Running time will be higher than normal. Suction line will sweat or frost. Reclaim excessive refrigerant from the system very carefully in small amounts waiting several minutes for the system to balance.

UNDERCHARGE: An undercharge or shortage of refrigerant will result in any of the following:

1. Lower than normal head pressure.
2. Lower than normal suction pressure.
3. Excessive or continuous operation of compressor.
4. Higher than normal cabinet temperature.

SERVICE AND ANALYSIS CHART

REFRIGERATION SYSTEM

MALFUNCTION	POSSIBLE CAUSE	SOLUTION
Compressor will not start - no hum.	<ol style="list-style-type: none"> 1. Line cord not plugged in. 2. Control stuck in open position. 3. Wiring improper or loose. 	<ol style="list-style-type: none"> 1. Plug in line cord. 2. Repair or replace control. 3. Check wiring against diagram.
Compressor will not start- hums but trips on overload protector	<ol style="list-style-type: none"> 1. Improperly wired. 2. Low voltage to unit. 3. Starting capacitor defective. 4. Compressor motor has a winding open or shorted. 	<ol style="list-style-type: none"> 1. Check wiring against diagram. 2. Determine reason and correct. 3. Determine reason and replace. 4. Determine reason and correct, replace if necessary.
Compressor starts but does not switch off of start winding.	<ol style="list-style-type: none"> 1. Low voltage to unit 2. Relay failing to open. 3. Run capacitor defective. 4. Compressor motor has a winding open or shorted. 	<ol style="list-style-type: none"> 1. Determine reason and correct. 2. Determine reason and correct replace if necessary. 3. Determine reason and replace. *4. Replace the compressor.
Compressor starts and runs, but short cycles on overload protector.	<ol style="list-style-type: none"> 1. Additional current passing through overload protector. 2. Low voltage to unit. 3. Overload protector defective. 4. Run capacitor defective. 5. Excessive discharge pressure. 6. Compressor too hot-return gas hot. 	<ol style="list-style-type: none"> 1. Check wiring diagram. Check for added fan motors, pumps, etc. connected to wrong side of protector. 2. Determine reason and correct. 3. Check current, replace protector. 4. Determine reason and replace. *5. Check ventilation, restrictions in cooling medium, restrictions in refrigeration. *6. Check refrigerant charge (fix leak if necessary)
Run capacitor open, shorted or blown	<ol style="list-style-type: none"> 1. Improper capacitor. 2. Excessively high line voltage 	<ol style="list-style-type: none"> 1. Determine correct size and replace. 2. Determine reason and correct.
Relay defective or burned out.	<ol style="list-style-type: none"> 1. Incorrect Relay 2. Line voltage too high or too low. 3. Relay influenced by loose vibrating mounting 	<ol style="list-style-type: none"> 1. Check and replace 2. Determine reason and replace. 3. Remount rigidly.
Space temperature too high	<ol style="list-style-type: none"> 1. Improper overcharge. 2. Inadequate air circulation. 	<ol style="list-style-type: none"> *1. Recover refrigerant and recharge with proper charge. 2. Improve air movement.
Unit noisy	<ol style="list-style-type: none"> 1. Loose parts or mountings 2. Tubing rattle 3. Bent fan blade causing vibration. 4. Fan motor bearings worn. 	<ol style="list-style-type: none"> 1. Find and tighten 2. Reform to be free of contact. 3. Replace blade. 4. Replace motor.

*** ALL SERVICING MUST COMPLY WITH STATE AND FEDERAL REQUIREMENTS.
FEDERAL LAW REQUIRES THAT SOME REFRIGERANT BE RECOVERED PRIOR TO SERVICING.**

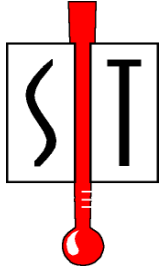

Scientemp™

3565 S. Adrian Hwy ♦ Adrian, MI 49221
800-968-2653 ♦ 517-263-6020 ♦ Fax 517-263-5492

Standard Warranty

Applies Only Within the Continental United States

SCIENTEMP WARRANTS TO THE ORIGINAL PURCHASER

FIRST 18 MONTHS – The cabinet and all of its parts shall be free of defects in material and workmanship under normal use and service for a period of 18 months from the date the unit has been shipped from our facility. Scientemp's sole obligation under this warranty shall be limited, at its option, to either repairing or replacing any part of the cabinet determined by an authorized service agent to be defective. Scientemp reserves the right to repair the freezer at our facilities.

THE SCIENTEMP STANDARD WARRANTY DOES NOT COVER

TRANSPORTATION COSTS – Scientemp shall not be responsible for transportation or incidental costs incurred in connection with the repair or replacement of a cabinet or any of its parts.

ABUSE, MISUSE, ACCIDENTS – Scientemp shall not be responsible for parts or assemblies which upon inspection are determined by an authorized Scientemp Service Agent to have been subjected to misuse, neglect, alteration, accident, abuse, damage during transit or delivery, or by fire or flood.

CONSEQUENTIAL DAMAGES – IN NO EVENT SHALL SCIENTEMP CORP BE LIABLE FOR SPECIAL, INDIRECT OR CONSEQUENTIAL DAMAGES, INCLUDING WITHOUT LIMITATION, PRODUCT LOSS OR PRODUCT SPOILAGE CLAIMS, NOR FOR ANY DELAY IN THE PERFORMANCE OF THIS WARRANTY DUE TO CAUSES BEYOND ITS CONTROL.

GENERAL

The standard warranty and any service contract related to the STANDARD WARRANTY shall apply only to the products sold and used within the boundaries of the Continental United States.

Users may file warranty claims either directly with Scientemp Corp, 3565 S. Adrian Hwy, Adrian, MI 49221, or with the seller from whom the cabinet was purchased. All claims must be supported by information concerning the alleged defect and specifically identified by the Serial Number of the cabinet.

THERE ARE NO OTHER WARRANTIES EXPRESS, IMPLIED, OR STATUTORY, EXCEPT THIS WARRANTY, WHICH IS IN LIEU OF ALL OTHER WARRANTIES INCLUDING TO THE EXTENT PERMITTED BY LAW, ANY IMPLIED WARRANTY OR MERCHANTABILITY OR FITNESS FOR A PARTICULAR PURPOSE.

DO NOT DRILL HOLES IN CABINET

Refrigeration tubing and wiring is routed through the cabinet walls. Leaks, wet insulation or electrical problems caused by drilling holes are not covered by warranty.

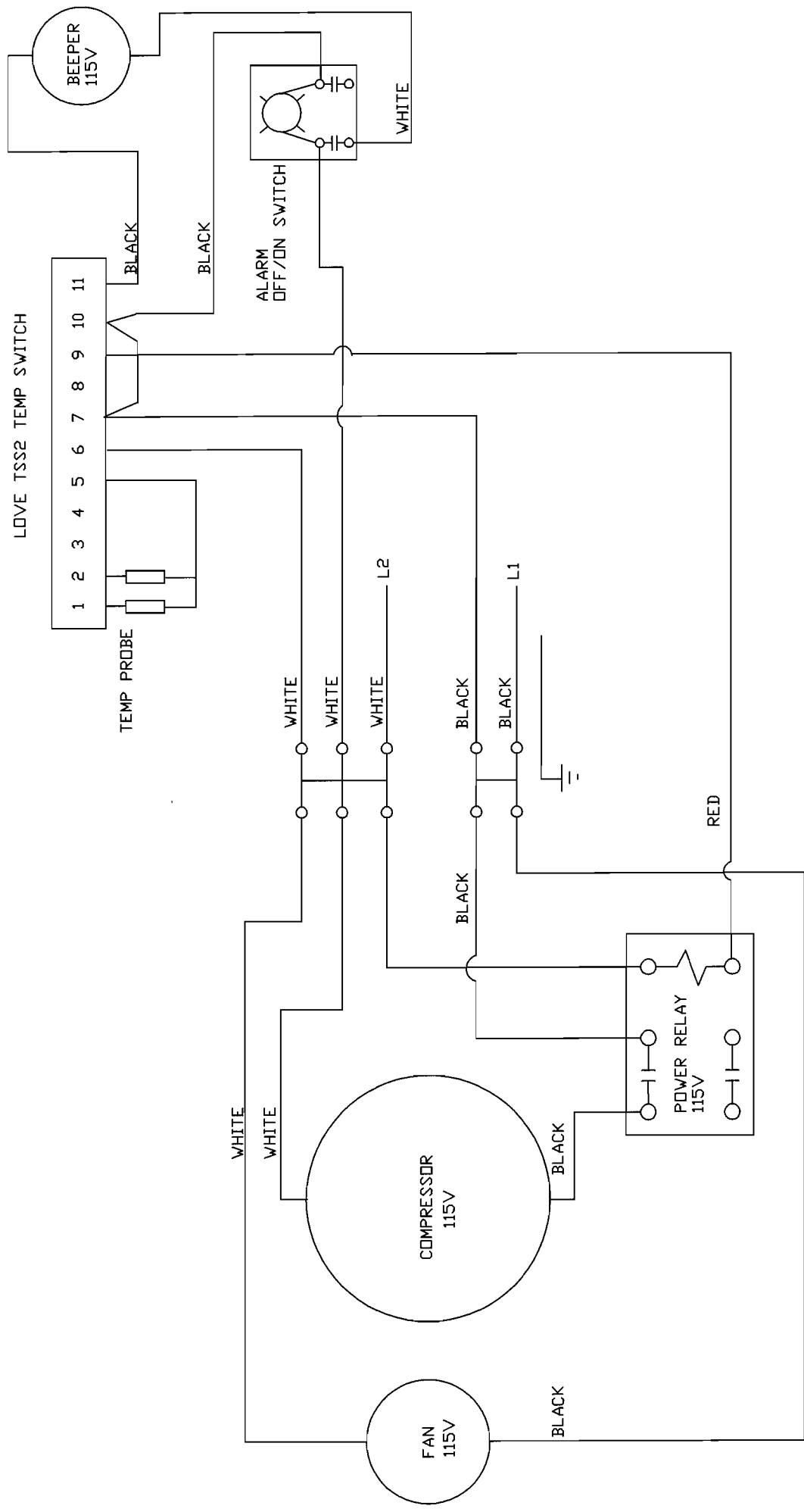

<u>LOVE TSS2 CONTROL CONFIGURATION</u>	<u>UNITS</u>	<u>VALUE</u>
SP1-SET POINT 1 (FREEZER TEMPERATURE)	DEGREES	-30
SP2-SET POINT 2 (ALARM SET POINT TEMPERATURE)	DEGREES	-24
RO-DEPENDENCY SP1,SP2	RANGE	IND
R1-DIFFERENTIAL FOR SP1	DEGREES	0.2
R2-DIFFERENTIAL FOR SP2	DEGREES	0.2
R3-BAND DIFFERENTIAL	DEGREES	0.2
R4-LOWEST VALUE FOR SP1	DEGREES	-99.9
R5-LOWEST VALUE FOR SP2	DEGREES	-99.9
R6-HIGHEST VALUE FOR SP1	DEGREES	99.9
R7-HIGHEST VALUE FOR SP2	DEGREES	99.9
R8-REGULATION OR OPERATING MODE	RANGE	ON1
A0-ALARM DIFFERENTIAL	DEGREES	0.3
A1- MAXIMUM ALARM PROBE 1	DEGREES	99.9
A2-MAXIMUM ALARM PROBE 2	DEGREES	99.9
A3-MINIMUM ALARM PROBE 1	DEGREES	99.9
A4-MINIMUM ALARM PROBE 2	DEGREES	99.9
A5-ALARM VERIFICATION TIME	H-M	0.1
C0-MINIMUM RELAY STOP TIME	MINUTES	0
C1-OPERATION RELAY 1	RANGE	DIR
C2-OPERATION RELAY 2	RANGE	DIR
C3- DEFAULT OPERATION RELAY 1	RANGE	CLO
C4-DEFAULT OPERATION RELAY 2	RANGE	CLO
P0-TEMPERATURE SCALE SELECTION	RANGE	C
P1- CALIBRATION OF PROBE 1	DEGREES	-1.5
P2-CALIBRATION OF PROBE 2	DEGREES	-1.5
P3-DECIMAL POINT	RANGE	YES
P4-PROBE TO BE DISPLAYED	RANGE	SD1
P5-NUMBER OF PROBES	RANGE	2
H0-REPROGRAMMING	RANGE	0
H1-KEYBOARD PROTECTION	RANGE	NO
H2-OPERATION LED OUT1	RANGE	DIR
H3-OPERATION LED OUT2	RANGE	DIR
H4-ADDRESS FOR SERIAL COMMUNICATION	NUMERIC	0
H5-ACCESS CODE TO PARAMETERS	NUMERIC	0

SETTING SP1 (TEMPERATURE SET POINT) AND SP2 (ALARM SET POINT)

PRESS AND RELEASE **SET**. THE CURRENT VALUE OF **SP 1** IS DISPLAYED.

SP1 AND **OUT 1** BLINK. PRESS **UP** OR **DOWN** TO INCREASE OR DECREASE THE VALUE.

PRESS **SET** TO CONFIRM THE NEW VALUE. THE ACTUAL VALUE OF **SP 2** IS DISPLAYED.

SP2 AND **OUT 2** WILL BLINK. PRESS **UP** OR **DOWN** TO INCREASE OR DECREASE THE VALUE.

PRESS **SET** TO CONFIRM THE VALUE AND EXIT.

PARAMETER SETUP

PRESS **SET** FOR 8 SECONDS. VALUE 0 BLINK.

WITH **UP** OR **DOWN** INPUT ACCESS CODE (FACTORY SET AS 0).

PRESS **SET** TO CONFIRM THE CODE. IF CORRECT THE, LABEL OF THE FIRST

PARAMETER WILL BE DISPLAYED. PRESS **UP** OR **DOWN** TO VIEW THE PARAMETER

FROM THE LIST. PRESS **SET** TO VIEW THE PARAMETER VALUE. PRESS **UP** OR **DOWN** TO

CHANGE THE VALUE. PRESS **SET** TO CONFIRM AND EXIT TO THE PARAMETER LIST.

PRESS **SET + DOWN** TO EXIT SETUP MODE OR WAIT ONE MINUTE.



Series TSS2 Dual Stage Temperature Switch

Specifications - Installation and Operating Instructions

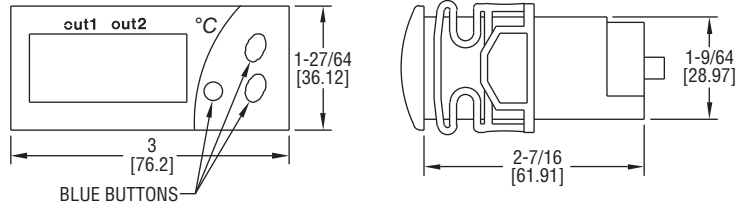

WIRING DIAGRAM

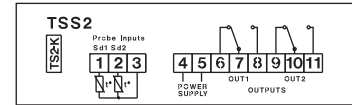

The TSS2 is an electronic temperature controller designed for ON/OFF control or Neutral Area Control. They can be provided with 1 or 2 probes (both PTC range -58 to 302°F) according to parameter P5 and it provides with two output relays plus an alarm buzzer. The unit controls cooling, heating or both, since its relays can be setup for direct or reverse operation. The user is able to program 34 different parameters including set points, hysteresis, configuration of alarms and probe adjustment using the silicone front keypad. The unit features error warning and password protection.

Each suffix can take the following values:

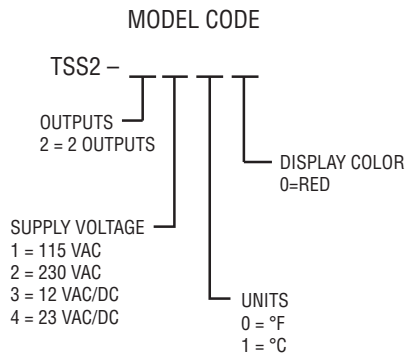

NOTE: Unit must be mounted away from vibration, impacts, water and corrosive gases.

- Cut hole in panel 71 x 29 mm (2.80 x 1.14 inches).
- Apply silicone (or rubber gasket) around the perimeter of the hole to prevent leakage.
- Insert unit into hole of panel.
- Slide removable fitting clips onto unit from the back until secure to panel.
- Wiring diagram is displayed on the top of the unit.
- **Note:** DO NOT INSTALL PROBE CABLE NEAR POWER CABLES.

SPECIFICATIONS

- Probe Range:** -58 to 302°F (-50 to 150°C).
- Input:** PTC thermistor (1000Ω @ 25°C).
- Outputs:** One 16A SPST relay @ 250 VAC, resistive; One 8A SPST relay @ 250 VAC resistive.
- Horsepower Rating (HP):** 1/3 HP.
- Power Requirements:** 12 VAC/DC, 24 VAC/DC, 115 VAC, 230 VAC depending on model.
- Accuracy:** 1% of full scale.
- Display:** 3-digit and sign, red LED.
- Resolution:** 0.1° (<100°); 1° (≥100°).
- Memory Backup:** Nonvolatile memory.
- Ambient Operating Temperature:** 32 to 158°F (0 to 70°C).
- Storage Temperature:** -4 to 176°F (-20 to 80°C).
- Dimensions:** 3 x 1-27/64 x 2-7/16 in.
- Front Panel Rating:** IP64.
- Weight:** 2.3 oz (65 g).
- Agency Approvals:** CE, UR.

Maintenance, cleaning and repair

After final installation of the unit, no routine maintenance is required. Clean the surface of the display controller with a soft and damp cloth. Never use abrasive detergents, petrol, alcohol or solvents. All repairs must be made by authorized personnel.

List of parameters

Description	Units	Range
SP1 Set Point 1	Degrees	r4 to r6
SP2 Set Point 2	Degrees	r5 to r7
r0 Dependency SP1-SP2	Range	ind/dep
r1 Differential for SP1	Degrees	0.1 to 20.0
r2 Differential for SP2	Degrees	0.1 to 20.0
r3 Band differential	Degrees	0.1 to 20.0
r4 Lowest value for SP1	Degrees	-99.9 to r6
r5 Lowest value for SP2	Degrees	-99.9 to r7
r6 Highest value for SP1	Degrees	r4 to 302
r7 Highest value for SP2	Degrees	r5 to 302
r8 Regulation or operating mode	Range	On1/On2/nEU
A0 Alarm differential	Degrees	0.1 to 20.0
A1 Maximum alarm probe 1 (1)	Degrees	0.1 to 99.9
A2 Maximum alarm probe 2 (2)	Degrees	0.1 to 99.9
A3 Minimum alarm probe 1 (1)	Degrees	0.1 to 99.9
A4 Minimum alarm probe 2 (2)	Degrees	0.1 to 99.9
A5 Alarm verification time	h-m (*)	0.0 to 18.0
A6 Alarm probe 1 selection	Range	AHL/Ano/AH/AL
A7 Alarm probe 2 selection	Range	AHL/Ano/AH/AL
c0 Minimum relay stop time	Minutes	0 to 240
c1 Operation relay 1	Range	dir/inv
c2 Operation relay 2	Range	dir/inv
c3 Default operation relay 1	Range	Opn/Clo
c4 Default operation relay 2	Range	Opn/Clo
P0 Temperature scale selection	Range	°C/°F
P1 Calibration of probe 1	Degrees	-20.0 to 20.0
P2 Calibration of probe 2	Degrees	-20.0 to 20.0
P3 Decimal point	Range	no/yes
P4 Probe to be displayed	Range	sd1/sd2
P5 Number of probes	Range	1/2
H0 Reprogramming	Range	0
H1 Keyboard protection	Range	no/yes
H2 Operation LED OUT1	Range	dir/inv
H3 Operation LED OUT2	Range	dir/inv
H4 Address for serial communication	Numeric	0 to 999
H5 Access code to parameters	Numeric	0 to 999

(*)h-m are data in format XX.Y where XX are hours and Y tens of minutes.
 (1)referred to set 1.
 (2)referred to set 2.

Parameter descriptions

SP1 = Operation order of relay 1. Specifies the ON/OFF point of relay 1. Variable between r4 and r6.
SP2 = Operation order of relay 2. Specifies the ON/OFF point of relay 2. Variable between r5 and r7.
r0 = Dependency between SP1 and SP2. Only for mode ONOFF1
 ind = order for relay 2, SP2.
 dep = order for relay 2, SP1+SP2.
r1 = Differential or hysteresis for relay 1. Temperature differential between ON/OFF of relay 1 in ON/OFF control.
r2 = Differential or hysteresis for relay 2. Temperature differential between ON/OFF of relay 2 in ON/OFF control.
r3 = Band differential. Temperature differential between ON/OFF of relays 1 and 2 in neutral area control. For relay 1 it is added to SP1 and for relay 2 it is subtracted from SP1.
r4 = Lowest value for SP1.
r5 = Lowest value for SP2.
r6 = Highest value for SP1.
r7 = Highest value for SP2.
r8 = Regulation or operating mode. Selection of the operating mode.
A0= Alarm differential. It is the temperature differential between the alarm On and Off cycle.
A1= Maximum alarm probe1.
A2 = Maximum alarm probe2.
 Maximum alarm ON when probe 2 higher than SP2+A2
 Maximum alarm OFF when probe 2 lower than SP2+A2-A0.
A3 = Minimum alarm probe1.
 Minimum alarm ON when probe 1 lower than SP1-A3
 Minimum alarm OFF when probe 1 higher than SP1-A3+A0.
A4 = Minimum alarm probe2.
 Minimum alarm ON when probe 2 lower than SP2-A4
 Minimum alarm OFF when probe 2 higher than SP2-A4+A0.

A5 = Alarm verification time. Time from the alarm event until it trips.
A6 = Alarm probe 1 selection.
 AHL=Maximum and minimum alarm probe 1 enabled.
 Ano=No alarms probe 1.
 AH=Maximum alarm probe 1 enabled.
 AL=Minimum alarm probe 1 enabled.
A7 = Alarm probe 2 selection.
 AHL=Maximum and minimum alarm probe 2 enabled.
 Ano=No alarms probe 2.
 AH=Maximum alarm probe 2 enabled.
 AL=Minimum alarm probe 2 enabled.

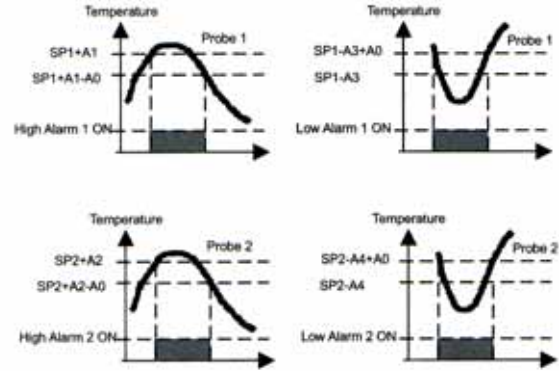

c0 = Minimum relay stop time. Minimum time from the disconnection of a relay until it can be switched on again.

c1 = Operation relay 1. Selection between direct or reverse operation for relay 1.
c2 = Operation relay 2. Selection between direct or reverse operation for relay 2.
c3 = Default operation relay 1. In case of failure of probe 1:
 oPn= relay 1 will remain open.
 Clo= relay 1 will remain closed.

c4 = Default operation relay 2. In case of failure of probe 1 (for all modes excepting ON OFF2) or in case of failure of probe 2 (for mode ON OFF2):
 oPn= relay 2 will remain open.
 Clo= relay 2 will remain closed.

P0 = Temperature scale selection.
P1 = Calibration of probe 1. Offset degrees to be added to probe 1.
P2 = Calibration of probe 2. Offset degrees to be added to probe 2.
P3 = Decimal point. If the displayed value of the probes is desired with decimals or not.
P4 = Probe to be displayed. Probe always on the display. The other probe can be seen pressing the keys SET+UP.
 sd1= probe 1.
 sd2= probe 2.

P5 = Number of probes. If P5=1, there is not ON OFF2 mode. If selected, it will operate as ONOFF1.

H0 = Reprogramming. Parameter to reprogram the thermostat.
H1 = Keyboard protection.

To change the sets, enter into parameter and exit again. The protection setting is momentarily released. It switches on again 1 minute after the last time a key was pressed.
 Yes= Keyboard Protected.
 No=Keyboard non protected.

H2 = Operation of LED OUT1.
dir= On when relay 1 is ON.
inv= On when relay 1 is OFF.
H3 = Operation of LED OUT2.
dir= On when relay 2 is ON.
inv= On when relay 2 is OFF.

H4 = Serial communication address. Address for computer connection.

H5 = Parameter entry code. Factory set as 0.

Message display

Under normal operation, the temperature of the probe selected by P4 will be displayed, the following messages may also appear:

- Err** Memory reading error.
- ErP** Error of the probe not shown on the display.
- AH1** Maximum temperature alarm, probe 1.
- AL1** Minimum temperature alarm, probe 1.
- AH2** Maximum temperature alarm, probe 2.
- AL2** Minimum temperature alarm, probe 2.
- ooo** Open probe.
- **---** Shorted probe.

Pressing SET with UP it displays the probe not selected by P4.

When the probe not selected by P4 is displayed, it alternates its value with message Sd1 or Sd2 depending if it is probe 1 or probe 2. The display blinks when waiting for a value confirmation.

LED indications

Out1: Indicates relay 1 On or Off as per parameter H2. If H2=dir, with relay 1 On, LED lit, if H2=inv, with relay 1 On, LED off. It blinks when SP1 is displayed.

Out2: Indicates relay 2 On or Off as per parameter H3. If H3=dir, with relay 2 On, LED lit, if H3=inv, with relay 2 On, LED off. It blinks when SP2 is displayed.

Setting SP1 and SP2

- Press and release SET. The current value of order 1 is displayed. SP1 and led OUT1 blink.
- Press UP or DOWN to increase or decrease the value.
- Press SET to confirm the new value. The actual value of order 2 will be displayed, SP2 and LED OUT2 blink.
- Press UP or DOWN to increase or decrease the value.
- Press SET to confirm the new value and exit.

Parameter setup

- Press SET for 8 seconds. Value 0 will blink.
- With UP and DOWN input the code (factory set as 0).
- Press SET to confirm the code. If correct, the label of the first parameter will be displayed.
- With UP or DOWN go to the desired parameter in the parameter list.
- Press SET to see the value.
- With UP or DOWN change the value to the new value as desired.
- Press SET to confirm and exit again to the parameter list. (Also to exit to the list without parameter modification.)
- Press SET + DOWN to exit setup or wait for 1 minute.

Resetting the keyboard code

You can setup to 0 the keyboard code switching the unit off and on while pressing the SET key.

Buzzer disconnection

Pressing SET with DOWN turns off the buzzer alarm. The message of alarm continue appearing in the display.

Reprogramming factory values (H0)

- Access to parameter H0 as explained in parameter setup.
- Value 0 will be displayed.
- Press SET for 8 seconds. Pro will be displayed if they have been setup correctly.
- Press SET + DOWN to exit setup or wait for 1 minute.

Description	Factory value
SP1 Set Point 1	10.0
SP2 Set Point 2	10.0
r0 Dependency SP1 - SP2	ind
r1 Differential for SP1	1.0
r2 Differential for SP2	1.0
r3 Band differential 1.0	1.0
r4 Lower value for SP1	-99.9
r5 Lower value for SP2	-99.9
r6 Higher value for SP1	99.9
r7 Higher value for SP2	99.9
r8 Regulation or operating mode	On1
A0 Alarm differential	0.1
A1 Maximum alarm probe 1	99.9
A2 Maximum alarm probe 2	99.9
A3 Minimum alarm probe 1	99.9
A4 Minimum alarm probe 2	99.9
A5 Alarm verification time	18.0
A6 Alarm probe 1 selection	AHL
A7 Alarm probe 2 selection	AHL
c0 Minimum relay stop time	0
c1 Operation relay 1	dir
c2 Operation relay 2	dir
c3 Default operation relay 1	Opn
c4 Default operation relay 2	Opn
P0 Temperature scale selection	°C
P1 Calibration of probe 1	0.0
P2 Calibration of probe 2	0.0
P3 Decimal point	yes
P4 Probe to be displayed	sd1
P5 Number of probes	2
H0 Reprogramming	0
H1 Keyboard protection	no
H2 Operation LED OUT1	dir
H3 Operation LED OUT2	dir
H4 Address for serial communication	0
H5 Access code to parameters	0

Operating modes

Mode ON OFF1 (On1) with r0=ind.

Relay 1 with c1=dir.

Temperature of probe 1 >= SP1+r1 -->relay 1 ON
 Temperature of probe 1 <= SP1 -->relay 1 OFF

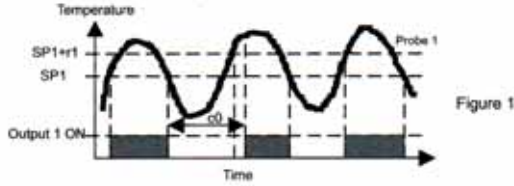

Relay 1 with c1=inv.

Temperature of probe 1 <= SP1-r1 -->relay 1 ON
 Temperature of probe 1 >= SP1 -->relay 1 OFF

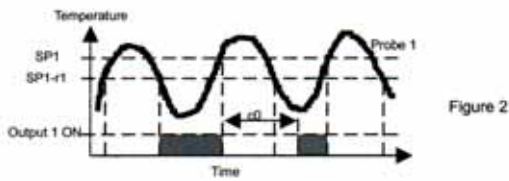

Relay 2 with c2=dir.

Temperature of probe 1 >= SP2+r2 -->relay 2 ON
 Temperature of probe 1 <= SP2 -->relay 2 OFF

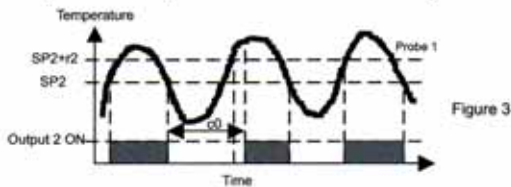

Relay 2 with c2=inv.

Temperature of probe 1 <= SP2-r2 -->relay 2 ON
 Temperature of probe 1 >= SP2 -->relay 2 OFF

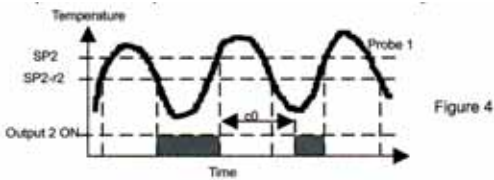

Mode ON OFF1 (On1) with r0=dep.

Output 1 works as in independent ON/OFF control (Figure 1 and 2), but output 2 works as follows:

Relay 2 with c2=dir.

Temperature of probe 1 >= SP1+SP2+r2 -->relay 2 ON
 Temperature of probe 1 <= SP1+SP2 -->relay 2 OFF

Relay 2 with c2=inv.

Temperature of probe 1 <= SP1+SP2-r2 -->relay 2 ON
 Temperature of probe 1 >= SP1+SP2 -->relay 2 OFF

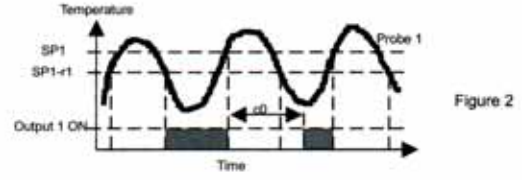

Mode ON OFF2 (On2)

Output 1 works as in independent ON/OFF control (Figure 1 and 2), but output 2 works as follows:

Relay 2 with c2=dir.

Temperature of probe 2 >= SP2+r2 -->relay 2 ON
 Temperature of probe 2 <= SP2 -->relay 2 OFF

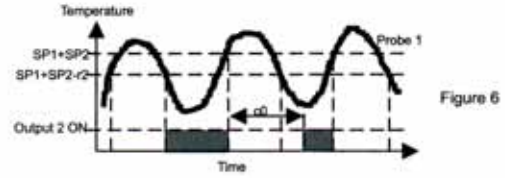

Relay 2 with c2=inv.

Temperature of probe 2 <= SP2-r2 -->relay 2 ON
 Temperature of probe 2 >= SP2 -->relay 2 OFF

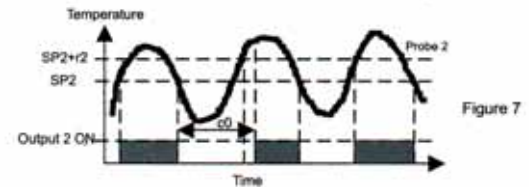

Neutral Area Mode (nEU)

Relay 1

Temperature of probe 1 >= SP1+r3 -->relay 2 ON
 Temperature of probe 1 <= SP1 -->relay 2 OFF

Relay 2

Temperature of probe 1 <= SP1-r3 -->relay 2 ON
 Temperature of probe 1 >= SP1 -->relay 2 OFF

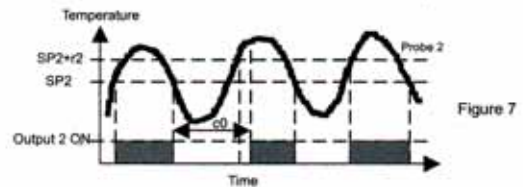

Operation in case of error.

If probe 1 fails, the operation is through c3. (See Parameter description.)

If probe 2 fails, the operation is through c4. (See Parameter description.)

In case of memory failure, both relays will remain open.